

Mirror By-Pass Top Hung Instructions

INSTALLATION INSTRUCTIONS

1. Trim Track to Fit Opening

Using a fine tooth hacksaw, cut the Top Fascia Track and Bottom Track $1/16"$ (2mm) shorter than the opening width.

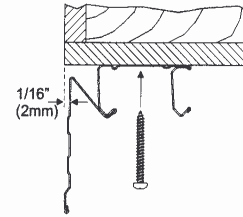
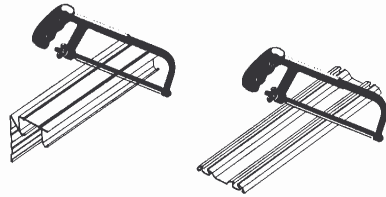

2. Attach Top Track

Screw in the Fascia Track to the header, locating the front edge $1/16"$ (2mm) back from the jamb face.

3. Attach Bottom Track

Locate the leading edge of the floor track $13/16"$ (21mm) back from the front face of the jamb so doors will hang plumb.

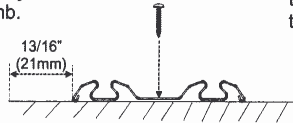

Note:

For installation over carpet it is recommended to cut the carpet and shim the track with wood strips.

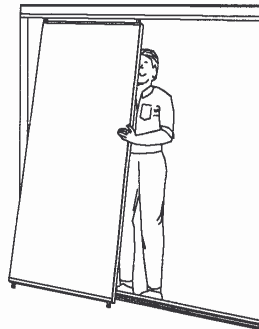
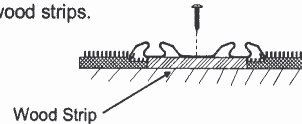

4. Install Doors

Tilt the door at a 20° angle, insert the top wheels of the door into the rear channel of the fascia track and allow the door to hang vertical. Snap the bottom guides into the rear groove of the bottom track using a flat head screwdriver as shown. Repeat for the front door.

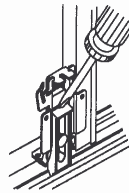

5. Adjust Doors

For vertical adjustment and plumb doors use a star crossed screwdriver to adjust the top rollers as shown.

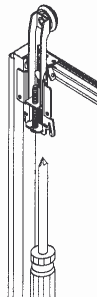

Cross-Sectional Layout of Installed Doors

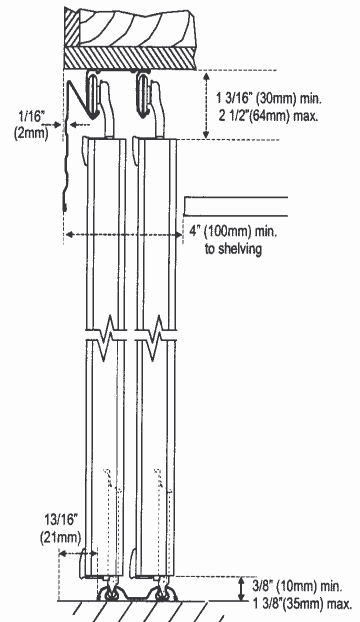

Mirror By-Pass Framed/Frameless Instructions

INSTALLATION INSTRUCTIONS

1. Trim Track to Fit Opening

Using a fine tooth hacksaw, cut the Top Guide Channel and Bottom Track $1/16"$ (2mm) shorter than the opening width. Insert 2x4 (51x102mm) wood blocks into channel for support.

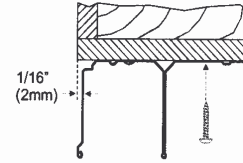
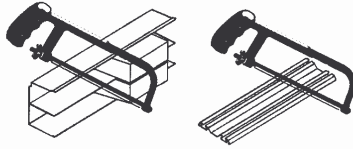

2. Attach Top Guide Channel

Screw Top Guide Channel into the header of your opening locating the front edge $1/16"$ (2mm) back from the jamb face as shown. Avoid using excessive force when screwing into header as this could deform the Top Guide Channel.

3. Attach Bottom Track

Locate the leading edge of the floor track $7/8"$ (22mm) back from the front face of the jamb so doors will hang plumb.

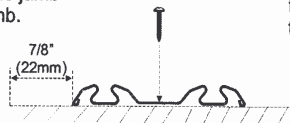

Note:

For installation over carpet it is recommended to cut the carpet and shim the track with wood strips.

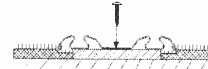

Wood Strip

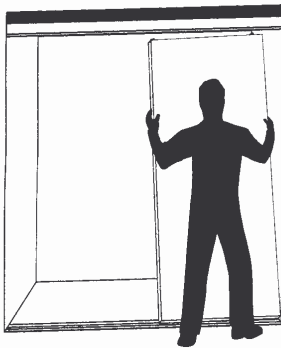

4. Install Doors

Tilt the door as shown, and insert the top guides into the rear channel. Insert the bottom rollers into the rear groove of the bottom track. To prevent scratching, place two pieces of wood or cardboard over the bottom track. Repeat with the second door, using the front channel and groove.

Cross-Sectional Layout of Installed Doors

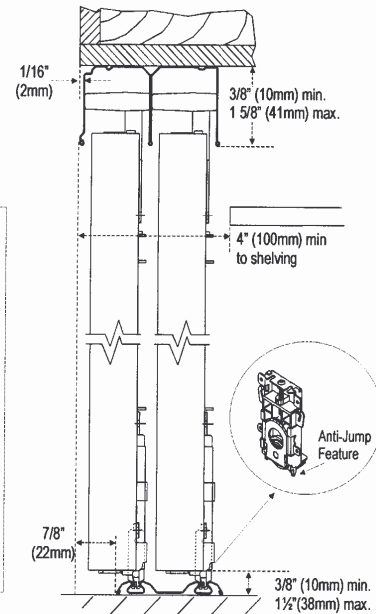

5. Adjust Doors

For vertical adjustment of each door use a star screwdriver on the bottom rollers as shown.

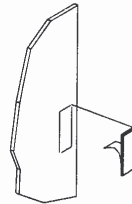
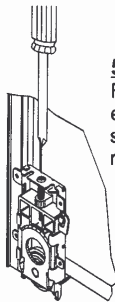

6. Attach Mirror Pulls

Attach mirror pull by peeling off the tape protection, as shown, and choose the desired height (approximately $40"$ (1016mm) high). The pull should be located approximately $1/2"$ (13mm) in from the door edge.