





MAKE SURE IT'S MARWIN-MADE.

Folding Attic Stairway Installation Instructions

For Residential Use Only

Important-Read This First

Before installing your new Folding Attic Stairway, read and understand the following:

- This stairway is completely assembled and ready for installation. Do not disassemble it to install.
- Do not open the stairway until instructed to do so on page 3.
- Use extreme caution when adjusting, checking or using this stairway. Never adjust or remove the spring when the stairway is in the open position.
- Check the ceiling height to make sure the stair length is correct. If the stair is too short, return it to the point of purchase for an exchange. Under no circumstances is any folding attic stair to be used when the ceiling-to-floor measurement exceeds the maximum ceiling height as indicated for the Ceiling Mounted Folding Attic Stair you are installing (See Specification Chart on Page 1.)
- When in the attic, be careful not to step through the ceiling.
- Check all nuts, bolts and screws for proper tightness prior to installation. Re-check these periodically after installation.
- Do not saw, drill or hammer into the ceiling until you are sure that the area is free from hazards and obstructions. Be especially careful not to contact electrical wiring.
- Do not stand on the attic stairway or leave it unattended until it is permanently nailed to the frame and the legs are properly trimmed.
- If the home has roof trusses, do not cut the ceiling joists without consulting an engineer.
- Use only 16d nails or 1/4 x 3" lag screws. Use of other fasteners such as finish nails, staples, sheet rock or deck-type screws can cause sudden catastrophic failure, and should never be used.
- Installation requires two people.
- To operate stairs with ceiling heights 10 feet or above, 2 people and a step ladder are recommended.
- This stairway is for **residential use only**. Commercial use can subject the stairway to undue stress which could result in collapse of the stairway and bodily injury.
- Always face the stairway and use the handrail when going up and down the stairway.
- Read and understand all instructions and labels before beginning work on the stairway.
- Carefully review all notes  and warnings .

Materials & Tools Required

- Claw hammer
- Ladder
- Saw
- Square
- 16d nails or 3" lag screws
- 8d nails
- Several joist-sized boards
- Tape Measure
- Adjustable wrench
- Slot-head screwdriver
- 21" x 4" boards (temporary slats)
- Material for shims
- Trim moulding
- Hack Saw (for aluminum models)
- Drill (for aluminum models)

Model #	Rough Opening	Max Ceiling Height	Landing Space	Projection	Model #	Rough Opening	Max Ceiling Height	Landing Space	Projection
A-75	22 1/2 X 48	8' 2"	54	65	T-200	30 x 54	8' 9"	58	66
A-80	22 1/2 x 54	8' 9"	58	67	T-201	30 x 54	10' 4"	66	76
A-81	22 1/2 x 54	10' 0"	66	77	T-2212	22 1/2 x 63	10'-12'	90	92
A-90	25 1/2 x 48	8' 2"	54	65	T-2512	25 1/2 x 63	10'-12'	90	92
A-100	25 1/2 x 54	8' 9"	58	67	T-3012	30 x 63	10'-12'	90	92
A-101	25 1/2 x 54	10' 0"	66	77	TBW-80	22 1/2 x 54	8' 9"	61	70
A-102	25 1/2 x 60	8' 9"	58	69	TBW-81	22 1/2 x 54	10' 4"	69	81
S-80	22 1/2 x 54	8' 9"	59	69	TBW-89	22 1/2 x 60	10' 9"	73	85
S-81	22 1/2 x 54	10' 0"	67	79	TBW-100	25 1/2 x 54	8' 9"	61	70
S-100	25 1/2 x 54	8' 9"	59	69	TBW-101	25 1/2 x 54	10' 4"	69	81
S-101	25 1/2 x 54	10' 0"	67	79	TBW-109	25 1/2 x 60	10' 9"	73	85
S-200	30 x 54	8' 9"	59	69	TBW-200	30 x 54	8' 9"	61	70
S-201	30 x 54	10' 0"	67	79	TBW-201	30 x 54	10' 4"	69	81
S-300	30 x 60	8' 9"	59	71	TBW-309	30 x 60	10' 9"	73	85
SP-89	22 1/2 x 60	10' 9"	71	83	TBA-80	22 1/2 x 54	8' 9"	60	68
SP-109	25 1/2 x 60	10' 9"	71	83	TBA-81	22 1/2 x 54	10' 4"	68	78
SP-309	30 x 60	10' 9"	71	83	TBA-100	25 1/2 x 54	8' 9"	60	68
T-80	22 1/2 x 54	8' 9"	58	66	TBA-101	25 1/2 x 54	10' 4"	68	78
T-81	22 1/2 x 54	10' 4"	66	76	TBA-200	30 x 54	8' 9"	60	78
T-100	25 1/2 x 54	8' 9"	58	66	TBA-201	30 x 54	10' 4"	68	78
T-101	25 1/2 x 54	10' 4"	66	76					

Locating the Stairway

- Step 1** Check to make sure that the attic area in which you intend to install the stairway is strong enough for walking and working on and has adequate headroom.
- Step 2** Position the opening for the stairway. Measure to be sure there is enough clearance for the stair as it swings to its full length (Fig. 1). Use the Specification Chart on the first page to determine the proper clearance for the projection and landing space. Be sure there is enough space for a safe landing area when the stairway is open.

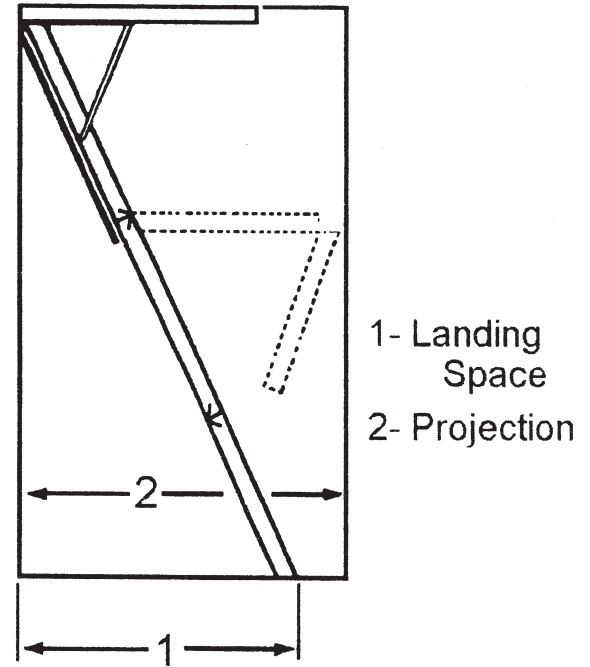





Fig. 1

Making & Framing the Rough Opening

-  **Locate all electrical wiring in the vicinity of the stairway installation area, and avoid contact with it during all phases of installation.**

- Step 1** Cut the rough opening through the ceiling material according to the size shown on the stairway carton.

-  The rough opening size of the stair, as listed on the carton, will be approximately 1/2" wider and longer than the actual net size of the stairway. This allows room for shimming and squaring the stairway in the opening.

-  Installation parallel to existing joists normally requires a frame with single headers. Installation perpendicular to the existing joist requires a frame with double headers. **If your home uses roof trusses, do not cut ceiling joists without engineering consultation and approval.**

-  If the folding attic ladder is wider than the spacing between the ceiling joists, you should consult a structural engineer before installing, since cutting into a ceiling joist could weaken the structural integrity of your ceiling.

- Step 2** If joists must be cut, stabilize them by nailing 2 joist-size stabilization boards perpendicular to the ceiling joists before cutting.

- Step 3** Using joist-size material, build a four-sided frame to install the stairway. Shaded areas in Fig. 2 & 3 illustrate the frame that must be built before installing the stairway. When making double headers (for perpendicular installation) fasten members together with 10d common nails. The double joist sections shown in Fig. 3 must be long enough to be supported by a load bearing wall at both ends.

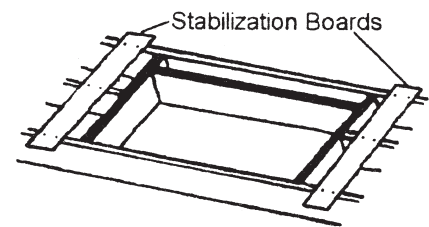

Fig. 2

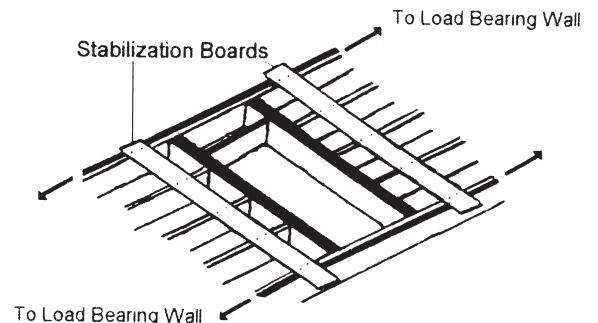

Fig. 3

Installing the Stairway

Installation into Engineered I-beam joist:

Preparation for the installation into engineered I-beam joist requires an engineer or architect to design the opening and attachment system. Carpenters experienced in using engineered I-beam joist should be utilized. Failure to follow these instructions may result in structural failure and collapse of stairway attachment system or portions of the building.

Step 1 Build two ledges to hold the stairway in the rough opening using 1" x 4" temporary slats which extend across the ends of the rough opening. Each slat should extend approximately 1/2" to 5/8" into the rough opening. If the length of the rough opening is not exact, be sure that there is enough ledge to overlap each end of the stair by 1/4" to 3/8". The slats should be nailed securely enough to hold the weight of the stairway (Fig. 4).

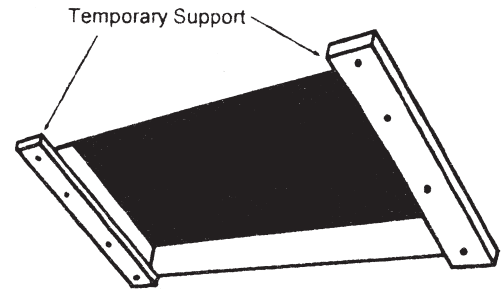

Fig. 4

⚠ Do not place any weight on the stair until permanent nailing is completed.

Step 2 With a helper in the attic, carefully raise the stairway into the rough opening, and position it on the ledges formed by the slats. Ensure that the plywood panel of the stairway is not blocked by the slats and is free to swing open.

⚠ Be sure the stair does not shift in the opening and come off the temporary slats.

As an extra precaution, temporarily drive an 8d nail through each side jamb of the stair, just above the stop blocks and into the rough opening frame (Fig. 5). Do not drive the nails in so deeply that they will be difficult to remove when the permanent nailing is completed.

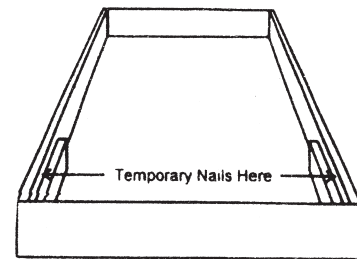

Fig. 5

Step 3 Carefully open the stairway from below.

⚠ Do not stand on the stairway at this time.

Make sure the stairway is square, level and firmly situated in the rough opening. Blocks of wood or plywood can be used as shims.

🔧 It is normal for the stair frame to become bowed while in inventory, because the wood parts are often subjected to strong spring tension for several months before installation. The frame, however, can be easily straightened by using nails and shims.

Step 4 Permanently mount the stairway using 16d nails or 3" lag screws in the locations shown in Fig. 6.

⚠ Square and start at hinge end of stair.

🔧 Two nailing holes have been pre-drilled on the end above the piano hinge. Pilot holes should be drilled if lag screws are used. It is recommended that nailing holes be pre-drilled by the installer. The pivot plate mount should be shimmed and nailed through the 2 holes in the plate.

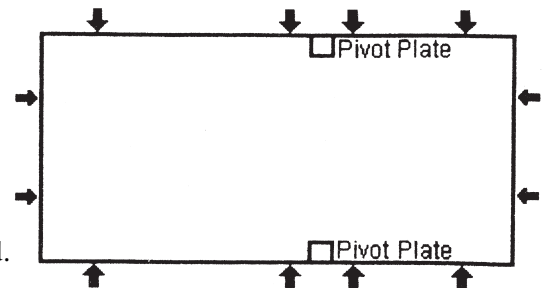



Fig. 6

Step 5 Remove the temporary slats and 8d nails. **Ref. step 2.**

Atlas and Superior Models Only

Cutting Stairs to the Proper Length

 Trim the stairs only after the floor beneath the stairs is finished. Adding or removing carpet or other flooring material will change the measurements for the length of the stairs.

- Step 1** Fully extend the folding section of the stairway. Press down on the stairs to ensure full extension.
- Step 2** Fold the bottom section of the stairway under the middle section, so that the top and middle sections form a straight line (Fig. 7).
- Step 3** Measure distance A and mark the distance on the A side of the bottom stringer. Measure distance B and mark the distance on the B side of the bottom stringer (Fig. 7). Draw a straight line between the points. It is possible for the landing area to be uneven, so repeat this procedure on the other stringer.
- Step 4** Cut each bottom stringer to the proper length, along the lines drawn. The bottom section of the stairs should fit flush with the floor on both sides after cutting.
- Step 5** Check to make sure the stairs fit flush with the floor and that all joints are tight with no gaps (Fig. 8). If the stairs are too long (Fig. 9), trim them again. If the stairs are too short (Fig. 10), do not use them. Contact your vendor or The Marwin Company.

 **Do not use the stairway unless the stairs fit flush with the floor, and the joints are tight with no gaps.**

See Separate Instructions for the Titan (Aluminum) Stairway.

Trimming the Stairway Opening

- Step 1** Select a moulding and trim around the stairway opening. Allow a gap of approximately 1/8" between the plywood panel of the stairway and the moulding.

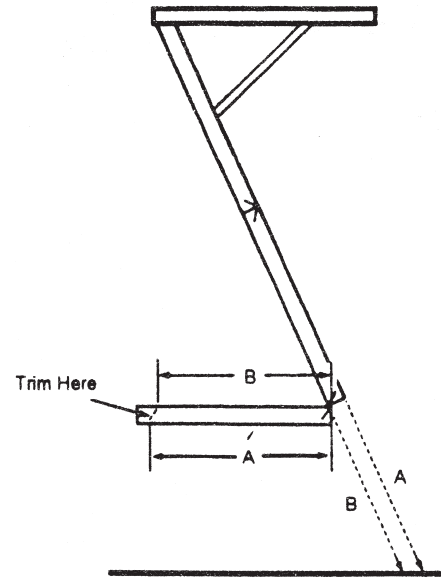

Fig. 7

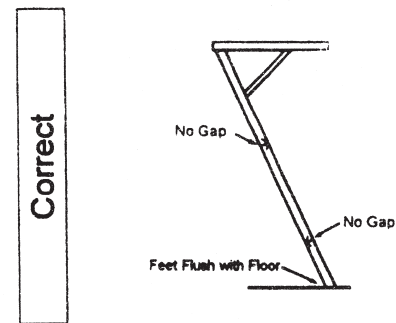

Fig. 8

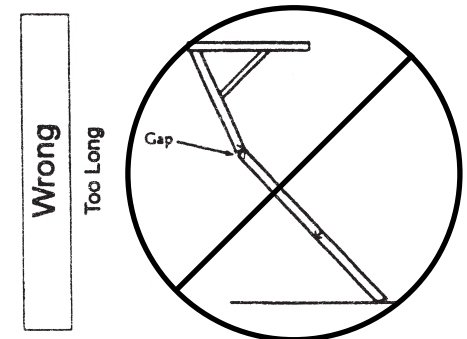

Fig. 9

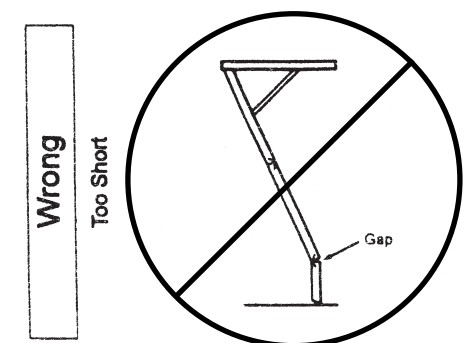

Fig. 10

Congratulations!

The installation of your Folding Attic Stairway is complete.

INSTRUCTIONS FOR CUTTING THE ALUMINUM STAIR TO PROPER LENGTH

Trim the stairs only after the floor beneath the stairs is finished. Adding or removing carpet or other flooring material will change the measurements for the length of the stairs.

STEP 1: Fully extend the folding sections of the stairway and fold the bottom section underneath the middle section to form a straight line (Fig. 1, Section A)

STEP 2: Measure distance A and mark the distance on the A side of the bottom stringer (Fig. 1). Mark this reference point on both sides of the stringer. Draw a straight line **3/4 inch above** these reference points. It is possible for the landing area to be uneven, so repeat this procedure on the other stringer.

STEP 3: The foot supports supplied with your stair should be attached according to length required to allow the bottom of the stair to fit flush with the floor (Fig. 2). According to the measurements taken in STEP 2, the bottom section may or may not need to be cut.

STEP 4: If cutting is necessary, cut each bottom stringer to the proper length along the reference line. Attach the foot supports with the nuts and bolts provided. A hole must be drilled in the bottom aluminum extrusion (if not pre-drilled) to attach the foot supports. The bottom of the aluminum extrusion must extend into the foot supports a minimum of 3 1/2 inches. The bottom section of the stairs should fit flush with the floor on both sides after cutting (Fig. 2).

STEP 5: Check to make sure the stairs fit flush with the floor and that all joints are tight with no gaps (Fig. 2). If the stairs are too long (Fig. 3), trim them again. If the stairs are too short (Fig. 4), do not use them. Contact your vendor or The Marwin Company.

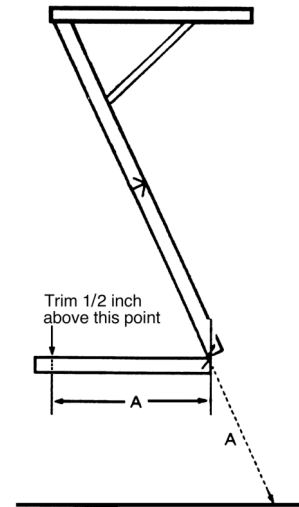

Fig. 1

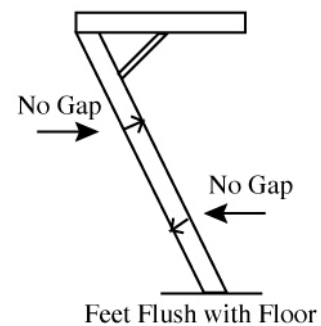

Fig. 2

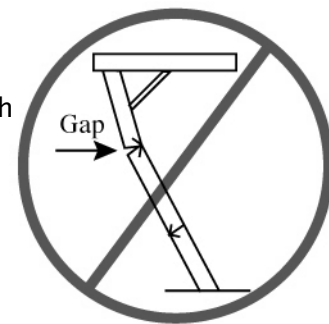

Fig. 3

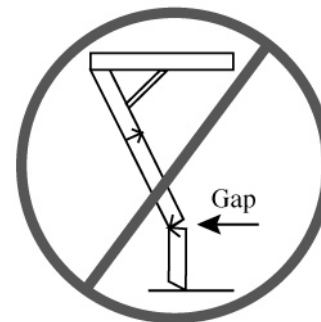
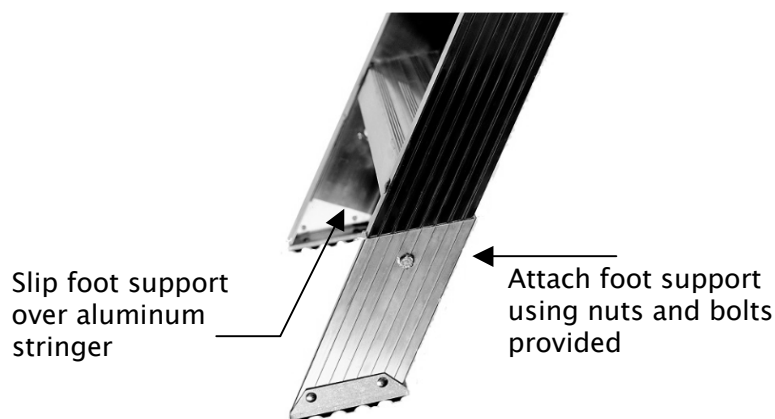

Fig. 4



Do not use the stairway unless the stairs fit flush with the floor and the joints are tight with no gaps.